



---

# WATER RESCUE

**PALM EQUIPMENT**

**GEAR FOR PROFESSIONALS**

Q424

---

## PROFESSIONAL EQUIPMENT FOR WATER RESCUE

**Keep yourself safe. Keep your team safe.  
Anticipate and avoid the hazards. Adapt to  
your environment and apply your advantage to  
save lives. These goals have motivated Palm  
Equipment since 1979. Our mission, now as  
then, to make better, safer equipment.**

We operate from our headquarters in Clevedon, UK with a European facility based in Asbach, Germany. Palm is in the unique position of having our own factory in Vietnam (ISO 9001 certified) employing the best manufacturing capability and technology available and with a keen eye for quality control – delivering to you more reliable products, made by people who know the importance of water rescue equipment.

We work with leaders and experts like Rescue 3 and the DLRG to bring the latest thinking to the design process. Amongst the first European companies to specialise in swift water rescue equipment, our history of innovation has contributed to safer and better experiences for water rescue users globally.



## WATER RESCUE PFDS



**CORDURA®**

Gaia PVC free foam floatation

Serial numbered for easy inventory management

UCLan size adjustable chest harness

**CORDURA®**

UCLan size adjustable chest harness

Velcro ID patch ready



### Palm Rescue Extrem PFD

The instructors' choice – low profile yet high float, great for mobility and swimming. Buoyancy is distributed by Flex Fit foam, which wraps around your torso. Equipped to the latest in swift water rescue best practice with the patented UCLan safety harness.

**12611** Rescue Extrem PFD

COLOUR(S) Red, Black

SIZES XS/S, M/L, XL/XXL

FEATURES • 3D anti ride-up waist belt • 50 mm chest harness webbing • Easy Glide straps • Extract Straps waistbelt sewn shoulder harness • shoulder straps tested to 3.2 kN • 7075 aluminium hardware • UCLan size adjustable chest harness with O-ring (patent GB2492084) • Flex Fit • buckle front entry • dual cowtail parks • easy access knife sleeve • front and rear velcro identification patches • Utility-draw front pocket • internal pocket compartments • internal rear velcro slip pocket • multiple accessory mount points • pocket clip-in point • reflective SOLAS tape • safety whistle included • inventory unique identification number • removable leg straps

CERTIFICATION ISO 12402-5/12402-6 certified (UKCA approved)

BUOYANCY XS/S (60 N), M/L (70 N), XL/XXL (75 N)

WEIGHT 1816 g (M/L)

MATERIALS CORDURA® 500D fabric, Gaia PVC-free foam

### Palm Rescue Universal PFD

A high-float, one size fits all PFD, which can outfit your whole team. With the adjustable UCLan safety harness, it's quick to adjust for a secure and safe fit. Fail-safe shoulder webbing and heavy duty CORDURA® material make this buoyancy aid strong and durable for extended service.

**12355** Rescue Universal PFD

COLOUR(S) Red

SIZES one size S-4XL

FEATURES • 3D anti ride-up waist belt • 50 mm chest harness webbing • Easy Glide straps • Fail-safe shoulder straps tested to 3.2 kN • UCLan size adjustable chest harness with O-ring (patent GB2492084) • adjustable shoulder straps • buckle front entry • dual cowtail parks • multiple accessory mount points • pocket clip-in point • two velcro front pockets • reflective SOLAS tape • safety whistle included • removable leg straps

CERTIFICATION ISO 12402-5/12402-6 certified (UKCA approved)

BUOYANCY S-4XL (100 N)

WEIGHT 2011 g

MATERIALS CORDURA® 500D fabric

## WATER RESCUE PFDS

### Palm Rescue Hybrid PFD

Gear up with the Rescue Hybrid, a fully tuneable PFD solution for water rescue teams. Adapt to your team or situation with MOLLE accessory attachment points. Fit a wide range of users safely and efficiently with the patented UCLan adjustable safety harness.

**12644** Rescue Hybrid PFD

COLOUR(S) Red, Black

SIZES XS/S, M/L, XL/XXL

FEATURES • 3D anti ride-up waistbelt • 50 mm chest harness webbing • Extract Straps waistbelt sewn shoulder harness • shoulder straps tested to 3.2 kN • 7075 aluminium hardware • UCLan size adjustable chest harness with O-ring (patent GB2492084) • adjustable shoulder straps • buckle front entry • dual cowtail parks • multiple accessory mount points • reflective SOLAS tape • safety whistle included • inventory unique identification number • removable leg straps • MOLLE compatible

CERTIFICATION ISO 12402-5/12402-6 certified (UKCA approved)

BUOYANCY XS/S (70 N), M/L (80 N), XL/XXL (90 N)

WEIGHT 1947 g (M/L)

MATERIALS CORDURA® 500D fabric, Gaia PVC-free foam



### MOLLE pockets

Adapt your Rescue Hybrid loadout with these pocket attachments. Two zipped front pocket options and a velcro rear pocket.

**12700** Rescue Front Safety Pocket

**12701** Rescue Front Accessory Pocket

**12702** Rescue Rear Storage Pocket





Gaia PVC free foam floatation

Serial numbered for easy inventory management

UCLan size adjustable chest harness

**NEW**

## Palm Rescue 850 PFD

The Rescue 850 is the industry standard for safety and rescue professionals. Tested in the toughest rescue situations the world over. Now updated with the size adjustable chest harness – for teams it can fit multiple users (no need to cut to length) – and it follows the latest quick release best safety practice for a clean tail release.

**12597** Rescue 850 PFD

COLOUR(S) Red

SIZES XS/S, M/L, XL/XXL

FEATURES • 3D anti ride-up waistbelt • 50 mm chest harness webbing • Extract Straps waistbelt sewn shoulder harness • shoulder straps tested to 3.2 kN • 7075 aluminium hardware • UCLan size adjustable chest harness with O-ring (patent GB2492084) • adjustable shoulder straps • buckle front entry • dual cowltail parks • two zip front pockets • velcro rear pocket • easy access knife sleeve • multiple accessory mount points • reflective SOLAS tape • safety whistle included • inventory unique identification number • removable leg straps

CERTIFICATION ISO 12402-5/12402-6 certified (UKCA approved)

BUOYANCY XS/S (70 N), M/L (80 N), XL/XXL (90 N)

WEIGHT 2162 g (M/L)

MATERIALS CORDURA® 500D fabric, Gaia PVC-free foam

# New features for the new 850



### 1 Adjustable UCLan chest harness

The chest strap tail at the quick-release buckle can be set at 3 cm independently of tightening the harness to fit at the side of the buoyancy aid. Following chest harness best practice.

### Improved fit

Newly contoured and pre-shaped buoyancy foam, tapers upwards so the vest fits even better for both men and women. The best fit is vital for security, mobility and active swimming.

### Enhanced visibility

The chest strap is now in signal yellow, all other straps in red instead of black.

### 2 Aluminum shoulder buckles

Buckles made from 7075 aerospace-grade aluminum with higher breaking strength replace the plastic buckles previously used on the shoulder straps.

### 3 Unique identification number

Each PFD is marked with a unique ID to help manage your inventory.

### Lash tabs

Lash tabs on the shoulders and additional webbing lash points on the chest provide stable mounting points for radios and other accessories.

### New front pocket design

The new pocket design, with pocket dividers and clip in points as well as an easy access slip pocket for a knife, organises your gear close to hand.



# UCLan clean tail release

Palm sponsored research<sup>1</sup> into PFD chest harness release found that one in four harnesses failed to open properly under low load. Harness belts were too long, creating a risk of entanglement when released. But by cutting the belt to the optimal length the PFD can no longer fit different users or accommodate more bulky garments underneath. Working with the team from University of Central Lancashire (UCLan), Palm developed a patented<sup>2</sup> load bearing system that allows the size to be adjusted independently of the release mechanism – keeping the belt's tail 3 cm in length, optimal for release.

<sup>1</sup> Onions C & Collins L 2013

<sup>2</sup> Patent GB2492084



VIDEO



FITTING  
GUIDE

## Retrofit adjustable UCLan chest harness for Rescue 850/800 PFDs

Upgrade your Rescue 850 or 800 inventory with this adjustable chest harness, making clean tail release simple.

**12134** Retrofit adjustable UCLan chest harness

COLOUR(S) Yellow

SIZES one size adjustable



## Replacement PFD leg straps

A replacement part for lost or damaged leg straps. Adding extra security and an extra point of connection to compatible rescue PFDs. These thigh straps are easy to install and adjust for a secure fit.

**13501/12257** Replacement PFD leg straps

COLOUR(S) Red

SIZES one size adjustable



## Palm Atlas jacket

A foul weather jacket designed with agility on or around the water in mind. Made from waterproof, breathable and durable XP 2.5-layer fabric. With ExoSkin wrist seals and a helmet compatible adjustable hood.

**12284** Atlas jacket

COLOUR(S) Red

SIZES S, M, L, XL, XXL

FEATURES • ExoSkin wrist gaskets • YKK AquaGuard zip front pockets • drawcord adjustable waist • front zip entry • reflective details • Velcro adjustable cuffs • volume adjustable hood (helmet compatible)

WEIGHT 552 g (L)

MATERIALS XP 2.5-layer fabric, breathability 5,000 g/m<sup>2</sup>/24hr (A-1 method), waterproofness 10,000 mm, 76% nylon 24% polyurethane

## DRYSUITS

Developed with Rescue 3 training centre Cardiff International White Water, the Palm search and rescue drysuit meets the demand for a hard working, comfortable suit, packed with features. Made from a high performance, breathable 4-layer fabric with tough 330D nylon face for durability. The flexible YKK AquaSeal front zips are individually tested by YKK. Each complete suit is also individually pressure tested at our factory. Easy to maintain and keep operational for frequent use. Designed with fewer seams for extra durability and ease of maintenance. The latex gaskets are glued to simplify your own in-house replacement.

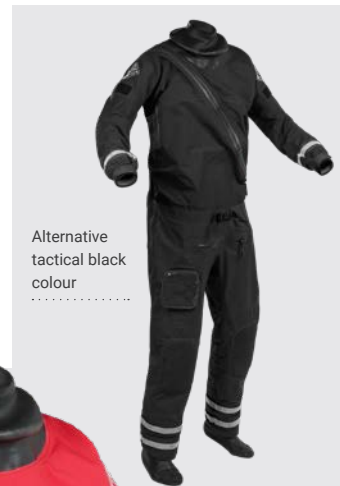

### Palm Rescue women's drysuit

**13745** Rescue women's suit

COLOUR(S) Red+Jet Grey

SIZES WS, WSR, WM, WL, WXL

FEATURES • YKK AquaSeal front entry zip • YKK AquaSeal dropseat relief zip • integral belt and braces • latex neck gasket • latex socks • latex wrist gaskets • padded Armortex reinforcement at elbows knees and seat • reflective SOLAS tape • thigh cargo and document pocket with writing surface • Velcro adjustable cuffs • Velcro shoulder patches for detachable ID • inventory unique identification number

WEIGHT 2100 g (L)

MATERIALS 285 g/m<sup>2</sup>, XP 4-layer fabric 320D throughout, breathability 5,000 g/m<sup>2</sup>/24hr (A-1 method), waterproofness 30,000 mm, 76% nylon 24% polyurethane

### Palm Rescue drysuit

**12137** Rescue suit

COLOUR(S) Red+Jet Grey, Black

SIZES S, M, MB, L, LT, XL, XXL

FEATURES • YKK AquaSeal front entry zip • YKK AquaSeal relief zip • integral belt and braces • latex neck gasket • latex socks • latex wrist gaskets • padded Armortex reinforcement at elbows knees and seat • reflective SOLAS tape • thigh cargo and document pocket with writing surface • Velcro adjustable cuffs • Velcro shoulder patches for detachable ID • inventory unique identification number

WEIGHT 2100 g (L)

MATERIALS 285 g/m<sup>2</sup>, XP 4-layer fabric 320D throughout, breathability 5,000 g/m<sup>2</sup>/24hr (A-1 method), waterproofness 30,000 mm, 76% nylon 24% polyurethane

## THERMAL INSULATION

### Palm Tsangpo suit

The ultimate one piece baselayer for cold conditions, made from super soft, stretchy Pontetorto fabric, treated with Polygiene odour control. The soft, natural feeling fleece, flatlock seam construction, and two way zip access make it so comfy you'll never want to take it off.

**11704** Tsangpo men's suit

COLOUR(S) Jet Grey

SIZES S, M, L, XL, XXL

**11746** Tsangpo women's suit

COLOUR(S) Jet Grey

SIZES WS, WM, WL, WXL

FEATURES • Polygiene odour control treated • flatlock seams • form fitting • thumb loops • two-way front zip (men's) • drop seat (women's) • zip chest pocket

WEIGHT 466 g (L)

MATERIALS Pontetorto Tecnostretch fleece, 65% polyester 25% polypropylene 10% elastane



Pontetorto Tecnostretch fleece used in our Tsangpo garments is Bluesign certified and has Polygiene odour control treatment.

**POLYGIENE**  
PONTETORTO®



### Palm Tsangpo long sleeve

Wear it under a paddle jacket, or as casual-wear off the water.

**11747** Tsangpo men's long sleeve

COLOUR(S) Jet Grey

SIZES S, M, L, XL, XXL

**11748** Tsangpo women's long sleeve

COLOUR(S) Jet Grey

SIZES WS, WM, WL, WXL

FEATURES • 1/2 front zip • Polygiene odour control treated • dropped rear hem • flatlock seams • form fitting • thumb loops • zip chest pocket

WEIGHT 305 g (L)

MATERIALS Pontetorto Tecnostretch fleece, 65% polyester 25% polypropylene 10% elastane



### Palm Tsangpo crew

Treated with Polygiene odour control, so you'll want to wear this one day after day.

**11779** Tsangpo crew neck long sleeve

COLOUR(S) Jet Grey

SIZES S, M, L, XL, XXL

FEATURES • Polygiene odour control treated • dropped rear hem • flatlock seams • form fitting

WEIGHT 259 g (L)

MATERIALS Pontetorto Tecnostretch fleece, 65% polyester 25% polypropylene 10% elastane



### Palm Tsangpo socks

Ideal for wearing inside drysuit socks. With Polygiene odour control treatment.

**11802** Tsangpo socks

COLOUR(S) Jet Grey

SIZES S, M, L, XL

FEATURES • flatlock seams

WEIGHT 45 g (L)

MATERIALS Pontetorto Tecnostretch fleece, 65% polyester 25% polypropylene 10% elastane



## FOOTWEAR

### Palm Gradient 3.0 boots

Our Vibram sole, moulded from confidence inspiring Idrogrip rubber, is the ultimate in wet traction. The insole can be removed if you want extra space inside for thick socks. The midsole's dual density foam cushions your heel and aids stability and control with denser foam on the forefoot.

**13705** Gradient boots

COLOUR(S) Black

SIZES 5 - 14

FEATURES • Vibram Idrogrip compound (IV UIAA) • dual density EVA midsole • lace up • includes second pair of laces • low profile heel • open tongue • pull tab • removable insole • scratch rubber heel counter • velcro neoprene ankle collar • ripstop mesh upper • welded rubber rand

WEIGHT 825 g (8)

MATERIALS 3 mm CR neoprene



## GLOVES



### Palm Rescue gloves

Warm 4 mm neoprene gloves with a thermal lining. Pre-bent fingers to help prevent fatigue and enhance dexterity.

**13735** Rescue gloves

COLOUR(S) Black

SIZES S, M, L, XL, XXL

FEATURES • grippy palm print • GlideSkin cuffs • Quick Dry thermal lining • glued and blindstitched seams • pairing snaps • pre-bent fingers

WEIGHT 168 g (L)

MATERIALS 4 mm CR limestone neoprene



### Palm Pro gloves

Tough gloves, reinforced with high-strength fibres for serious work in cold and wet conditions.

**12331** Pro gloves

COLOUR(S) Red

SIZES S, M, L, XL, XXL

FEATURES • Amara reinforced back of the hand • Armortex reinforced palms and fingers • pull tab • titanium insulation • Velcro adjustable cuff • Velcro adjustable volume

WEIGHT 151 g (L)

MATERIALS 2 mm CR limestone neoprene

## HELMETS

### Palm Shuck 2.0 helmet

With a tough ABS shell, multi-impact EPP liner and removable ear pads. Dial in your fit with the occipital stabiliser keeping the helmet secure and seated in place. The quick drying fabric liner which cups your head is treated with Polygiene odour control to keep it fresh (it's washable too).

**13733** Shuck 2.0 helmet

COLOURS Red, White, Black, Teal

SIZES S (51-54 cm), M (55-58 cm), L (59-62 cm)

FEATURES • removable ear pads • Polygiene odour control treated • adjustable straps with side release buckle • chin strap protector • dial adjustable occipital stabiliser • quick drying comfort liner • self adhesive fit pad kit

CERTIFICATION CE EN1385 watersport safety standard (UKCA approved)

WEIGHT 555 g (L)

MATERIALS ABS injection moulded plastic shell, EPP multi-impact foam liner



#### POLYGIENE

Removable, washable liner  
Dial adjustable occipital stabiliser



### Palm AP 4000 helmet

A low profile half-cut helmet, injection moulded in polypropylene for impact protection with an easy to operate slide adjustable inner cradle for a secure and comfortable fit.

**11841** AP4000 helmet

COLOURS Red, White, Yellow

SIZES adjustable S (51-56 cm), L (56-60 cm)

FEATURES • slide adjustable inner cradle • soft webbing chinstrap • vents for ventilation and drainage • water-resistant foam lining

CERTIFICATION CE EN1385 watersport safety standard (UKCA approved)

WEIGHT 478 g (L)

MATERIALS high-impact polypropylene



Special order decals  
+ colour ways

Pinch and slide cradle  
size adjustment



## Palm AP2000 helmet

A full-cut helmet, injection moulded in polypropylene for impact protection with an easy to operate ratchet inner cradle for a secure and comfortable fit.

**11480** AP2000 helmet

**COLOURS** Red, White, Yellow

**SIZES** one size adjustable (52-58 cm)

**FEATURES** • slide adjustable inner cradle • soft webbing chinstrap • vents for ventilation and drainage • water-resistant foam lining

**CERTIFICATION** CE EN1385 watersport safety standard (UKCA approved)

**WEIGHT** 529 g

**MATERIALS** high-impact polypropylene



## HEADWEAR



### Palm Tsangpo hat

A fleece beanie hat great for wearing under your helmet or kept in a drybag for emergencies.

**11801** Tsangpo hat

**COLOUR(S)** Jet Grey

**SIZES** one size

**FEATURES** • Polygiene odour control treated • double layer headband • flatlock seams • form fitting

**WEIGHT** 36 g

**MATERIALS** Pontetorto Tecnostretch fleece, 65% polyester 25% polypropylene 10% elastane



### Palm Pilot cap

Quick Dry thermal lined 2 mm neoprene, flatlock stitched for comfort. Keep your head warm in the cold water.

**12337** Pilot cap

**COLOUR(S)** Jet Grey

**SIZES** one size

**FEATURES** • Quick Dry thermal lining • glued and blindstitched seams • over ear coverage

**WEIGHT** 57 g

**MATERIALS** 2 mm CR limestone neoprene

## THROWLINES

### Palm Pro throwline

A rescue throwline with detachable, easy-to-handle floating rope with a Quickclip clean line attachment point. Our Pro throwlines are adaptable with belt attachment points, wide neck opening and floating bags.

12274	Pro 25 m throwline
-------	--------------------

12273	Pro 20 m throwline
-------	--------------------

12272	Pro 15 m throwline
-------	--------------------

COLOUR(S) High-vis

FEATURES • 10 kN static breaking strength • Quickclip clean line attachment point • buoyant foam padding • compatible with 12711 Quick Rescue belt and 12712 Quick Pro belt • high visibility colour • reflective details • rope can be untied from bag • shock cord neck closure

DIMENSIONS 15 m, 20 m, or 25 m rope length • 11 mm Ø rope

WEIGHT 875 g (15 m), 1160 g (20 m), 1423 g (25 m)

MATERIALS 11 mm Ø floating polypropylene kernmantle rope, CORDURA® 500D bag



### Palm Arc 12.5 m throwline

The best throwline is the one you have with you. Carton shaped with a flat profile, it's easy to slip inside your PFD and even more out of the way on a throwline belt. The Velcro lid holds its shape when the bag is open and acts as a handle to grasp the bag, making repacking easy.

12715	Arc 12.5 m throwline
-------	----------------------

COLOUR(S) Ocean+Lime

FEATURES • 8 kN static breaking strength • Quickclip clean line attachment point • compatible with 12711 Quick Rescue belt and 12712 Quick Pro belt • high visibility colour • rope can be untied from bag • velcro fastening closure

DIMENSIONS 12.5 m rope length • 8 mm Ø rope

WEIGHT 481 g

MATERIALS 8 mm Ø floating polypropylene kernmantle rope, CORDURA® 500D bag





# Clean line principle

Any loop or knot has a risk of entangling the line or worse the swimmer in the water. Our throwlines are designed to minimize the risk of snagging. The Quickclip clean line attachment on our throw bags is a webbing connector sized for a karabiner that makes an obvious and easily clipped point of connection. The rope inside can be untied from the bag when necessary for using the rope with a clean tail at both ends.



## RESCUE BELTS

### Palm Quick Rescue belt

A versatile quick-release belt for attaching a throwline, with MOLLE webbing for pouches and accessories. Our clean tail safety release system separates the quick release and the waist adjustment buckle, so that the quick release tail is always the right length and the belt can be easily adjusted for people of all sizes with the spare webbing neatly coiled away.

**12711** Quick Rescue belt

**COLOUR(S)** Jet Grey

**SIZES** one size adjustable

**FEATURES** • MOLLE compatible • Vent Mesh liner • buoyant foam padding • cam quick-release buckle • compatible with all Palm throwlines • locator tabs for all Palm throwline sizes • reflective details • size adjustment side release buckle • throwline/leash attachment point with independent quick-release buckle

**WEIGHT** 273 g

**MATERIALS** 38 mm nylon webbing, nylon 420D ripstop fabric



### Accessory pouches

MOLLE accessory pouches for the Quick Rescue belt. A tubular drawstring pouch for holding a water bottle up to 9 cm diameter and a one litre capacity zipped cargo pouch with internal pocket divider.

**13334** Quick H2O pouch

**13333** Quick Cargo pouch



MOLLE compatible  
webbing attachment

## Palm Quick Pro belt

A versatile quick-release belt for attaching a throwline, with a clamshell zip pocket for your pin kit or anything else you need close to hand. It can also be converted into a waist belt topline, with room in the pocket for a 5 m Snake Sling.

### 12712 Quick Pro belt

COLOUR(S) Jet Grey

SIZES one size adjustable

FEATURES • Vent Mesh liner • YKK Vislon zip • buoyant foam padding • cam quick-release buckle • clean tail safety release system • compatible with all Palm throwlines • internal pocket compartment • locator tabs for all Palm throwline sizes • reflective details • roll away Velcro strap tidy • size adjustment side release buckle • strong tow loop inside pocket • throwline/leash attachment point with independent quick-release buckle • zipped stow pocket

WEIGHT 336 g

MATERIALS 38 mm nylon webbing, nylon 420D ripstop fabric, polyester 210D fabric lining



## Clean tail release

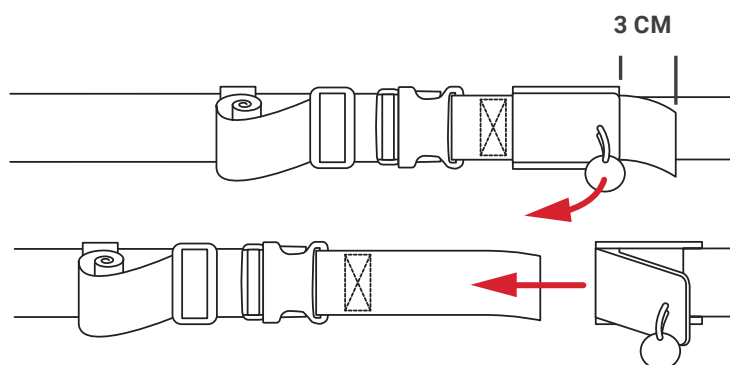

Following the research on quick release tethers from UCLan and adopting the same principle as our PFD chest harnesses, our waist belts are more adjustable and more reliable, eliminating the need to cut your belt to length. By separating the quick release and the waist adjustment buckle, the quick release tail is always the optimal length and the belt can be easily adjusted for people of all sizes with the spare webbing neatly coiled away.

## RESCUE EQUIPMENT



### Palm Snake Sling

A versatile 4 m sling. Its two sewn end loops can be joined with a karabiner to make a continuous loop.

**13731** Snake Sling

COLOUR(S) Red

FEATURES • 13 kN static breaking strength (3σ) • 25 mm tubular nylon tape • high visibility colour • karabiner loops at both ends • inventory unique identification number

DIMENSIONS 4 m tape length



### Palm Safety Tape

This 5 m tape fits neatly in the front pocket of your PFD. With Velcro fastening to keep it in a tidy coil.

**10538** Safety Tape

COLOUR(S) Yellow

FEATURES • 10 kN static breaking strength • 25 mm tubular nylon tape • high visibility colour • karabiner loop at one end • neoprene karabiner grip • Velcro fastening

DIMENSIONS 5 m tape length



### Palm Cobra Sling

This 4 m space-saving tape is super low profile in your PFD pocket. Made from 10 mm UHMWPE webbing.

**12708** Cobra Sling

COLOUR(S) Red+white

FEATURES • 10 kN static breaking strength • 10 mm UHMWPE webbing • high visibility colour • karabiner loops at both ends

DIMENSIONS 4 m tape length



### Palm Cowtail Pro

An elasticated attachment for use with PFD harness systems upgraded with an anodised aluminium O-ring.

**12709** Cowtail Pro

COLOUR(S) Red+yellow

FEATURES • 12 kN static breaking strength (3σ) • 25 mm tubular nylon tape • 7075 aluminium O-ring • high visibility colour • karabiner loop • neoprene karabiner grip • recommended for use with screw gate karabiners • 48 mm anodised aluminium O-ring • inventory unique identification number

DIMENSIONS 50 cm elasticated tape, 75 cm extended



### Palm Cowtail

An elasticated attachment for use with personal floatation device harness systems.

**10543** Cowtail One (with steel O-ring)

**10544** Cowtail Two

COLOUR(S) Yellow

FEATURES • 5 kN static breaking strength • 25 mm tubular nylon tape • high visibility colour • karabiner loop • neoprene karabiner grip • recommended for use with screw gate karabiners • stainless steel O-ring (Cowtail One)

DIMENSIONS 50 cm elasticated tape, 75 cm extended



### Palm Folding Knife

A low profile water rescue knife fits neatly in a PFD knife pocket. The bite pull-tab is a simple addition which makes it easier to open one-handed.

**11479** Folding Knife

COLOUR(S) Red

FEATURES • pull tab • round nose blade • serrated edge

DIMENSIONS 30 x 110 x 13 mm (closed) • 70 mm blade

MATERIALS nylon glass filled handle, stainless steel blade



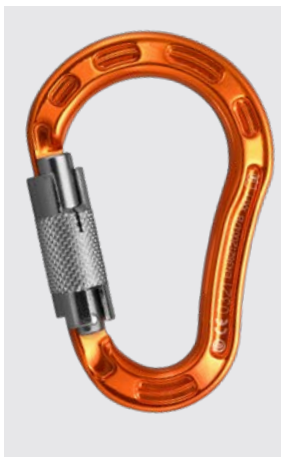

### Palm Side Swing HMS Autolock karabiner

Quick to operate single twist autolock action gate. The gate opens at an angle for a larger 26 mm opening.

**12431** Side Swing karabiner

COLOUR(S) Orange

FEATURES • auto lock opening • clean nose • gate opening 26 mm • major axis strength 22 kN • minor axis strength 10 kN

CERTIFICATION CE EN122275, UIAA approved

MATERIALS anodised aluminium



### Palm Autolock karabiner

Quick to operate single twist autolock action gate. Anodised finish and clean nose closure.

**10545** Autolock karabiner

COLOUR(S) Silver

FEATURES • auto lock opening • clean nose • gate opening 24 mm • major axis strength 28 kN • minor axis strength 8 kN • open gate strength 8 kN

CERTIFICATION CE EN362, UIAA approved

MATERIALS anodised aluminium

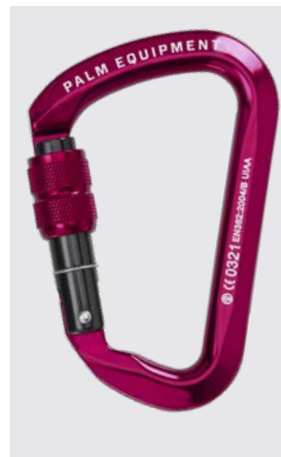

### Palm Screw Gate karabiner

A screw gate karabiner with anodised finish and clean nose closure.

**10541** Screw Gate karabiner

COLOUR(S) Red

FEATURES • clean nose • gate opening 23 mm • major axis strength 24 kN • minor axis strength 7 kN • open gate strength 7 kN • screw gate opening

CERTIFICATION CE EN362, UIAA approved

MATERIALS anodised aluminium



### Palm Wire Gate karabiner

A large wire gate karabiner with a generously large gate opening, which fits over most paddle shafts.

**10540** Wire Gate karabiner

COLOUR(S) Gold

FEATURES • gate opening 35 mm • major axis strength 22 kN • minor axis strength 8 kN • open gate strength 7 kN • wire gate opening

CERTIFICATION CE EN362, UIAA approved

MATERIALS anodised aluminium



### Palm Prusik Minding Pulley

A swing cheek pulley with prusik minding side plates. Compact enough for your PFD pocket.

**12602** Prusik Minding Pulley

COLOUR(S) Purple

FEATURES • 30 kN static breaking strength (15 kN in each strand) • ball bearing • max rope  $\varnothing$  11 mm • swing sided opening • working load limit 5 kN (2.5 kN in each strand)

CERTIFICATION EN 12278, UIAA approved

MATERIALS anodised aluminium



### Palm Survival Shelter

For up to six people to temporarily shelter from the elements. Packs down into its own drybag.

**12402** Survival Shelter

COLOUR(S) Flame

FEATURES • reflective details • storage bag • window and air vent

DIMENSIONS 160 x 100 x 90 cm (l x w x h)

WEIGHT 822 g

MATERIALS anodised aluminium



### Fox 40 Micro Whistle

A compact three-chamber design with no moving parts can produce up to 110 decibels.

**10546** Fox 40 Micro Whistle

COLOUR(S) Red

FEATURES • includes lanyard • peaseless 3 chamber design • up to 110 dB

CERTIFICATION ISO 12402-8 certified

MATERIALS injection moulded plastic

## ACCESSORIES



### Palm Poncho Grande

A weatherproof ripstop changing robe with a microfleece towel lining. Driving wind and rain? No need to run for cover.

<b>11783</b>	Poncho Grande
COLOUR(S) Jet Grey	
DIMENSIONS 90 x 110 cm	
WEIGHT 875 g	
MATERIALS 300 g/m <sup>2</sup> microfibre polyester towel, polyester 75D ripstop fabric	



### Palm Poncho

This microfleece towel changing robe has a hood, hand warmer pockets and wide arm holes.

<b>11847</b>	Poncho
COLOUR(S) Aqua	
DIMENSIONS 90 x 110 cm	
WEIGHT 772 g	
MATERIALS 300 g/m <sup>2</sup> microfibre polyester towel	



### Palm Universal Mat

A foam changing or kneeling mat with a durable ripstop cover. Folds in half for storage.

<b>11455</b>	Universal Mat
COLOUR(S) Jet Grey	
DIMENSIONS 43 x 45 x 2 cm	
WEIGHT 135 g	
MATERIALS polyester ripstop fabric	



### Palm Eyewear Band

A simple neoprene glasses retainer. Thread the arms of your glasses through the neoprene tubes at each end.

<b>12338</b>	Eyewear Band
COLOUR(S) Jet Grey	
WEIGHT 5 g	
MATERIALS 2.5 mm CR limestone neoprene	

### Palm River Trek drybag

A tough, waterproof roll-top backpack with a heavy duty padded shoulder harness and an adjustable chest strap to aid stability.

<b>12348</b>	River Trek drybag
COLOUR(S) Chilli+Jet Grey	
SIZES 125 L, 100 L, 75 L, 50 L	
FEATURES • D-ring attachment point • backpack shoulder straps • backpack sternum strap • daisy chain attachment points • double stitched reinforced seams • roll down closure	
DIMENSIONS 125 litres • 95 x 50 x 31 cm	
100 litres • 95 x 39 x 27 cm	
75 litres • 80 x 39 x 27 cm	
50 litres • 70 x 36 x 23 cm	
WEIGHT 1211 g (100 L)	
MATERIALS PU coated 420D fabric, PU coated 500D CORDURA® base, PVC-free	



PVC free ruggedised waterproof material

## OUR IMPACT

Palm was the first company to introduce Gaia non-PVC foam into our buoyancy aids and we continue to find low impact alternatives wherever possible. Removing PVC from our drybags; using limestone non-petroleum neoprene; and introducing recycled nylon fabrics. In our supply chain we ship 99.7% of our goods by sea, producing fifty-five times less CO<sub>2</sub> than air freight. Goods are packed in cartons using

paper tape – saving 198 km of plastic tape and removing 1,500 kg of plastic bags each year. But possibly the greatest impact we have is making gear that lasts. From the specification of a new design to our quality control at every step along the way, everything must exceed the standard. Premium components like YKK zippers, CORDURA® nylons and Gaia foam, help make gear that works time after time – so Palm gear outlasts the others.



### Palm Mega Holdall

Big enough to carry all your kit, or to store sets of equipment for group use. Nylon 1680D fabric, hard-wearing, but supple enough to be rolled away when not in use.

**12442** Mega Holdall

**COLOUR(S)** Black

**SIZES** 95 L, 150 L

**FEATURES** • large full length two-way zip • two shoulder carry straps • two webbing drag handles

**DIMENSIONS** 150 litres • 82 x 43 x 43 cm  
95 litres • 70 x 37 x 37 cm

**WEIGHT** 1104 g (95 L), 1295 g (150 L)

**MATERIALS** 1680D nylon fabric

# Sizing

## GETTING THE RIGHT FIT

**Chest**—measure horizontally under the armpits around the fullest part of your chest and shoulder blades.

**Bust**—measure horizontally round the fullest part of your bust.

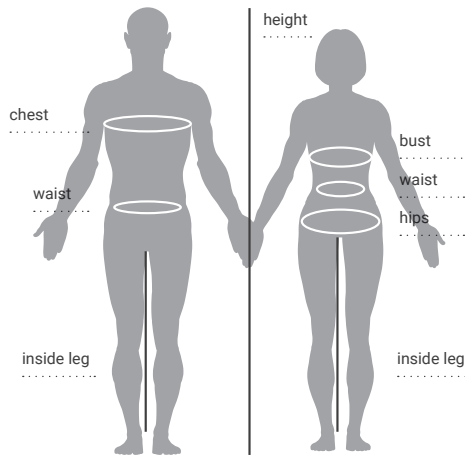

**Waist**—measure the waist circumference at the smallest part of your waist, often at the belly button. For most women this is about an inch above the belly button.

**Hips**—measure the fullest part of your hips.

**Inside leg**—measure from your ankle bone to your groin.

**Weight**—include all the gear you'll be wearing too.

## PERSONAL FLOATATION SIZING

### PFD BUOYANCY LABEL

A correct fit is more important than choosing the buoyancy category according to your weight. All Palm PFDs have buoyancy above the minimum floatation required for CE/ISO and UKCA certification. PFD weight ranges are printed inside Palm PFDs on the ISO label.

Bear in mind the clothing you choose to wear will also affect your ability to swim. Putting things in your pockets will also add overall weight. Consider what you will be carrying and wearing when choosing a PFD size.

### UNISEX PFDs

	XS/S	M/L	XL/XXL	S - 4XL
Chest	78 - 94 cm 31 - 37"	94 - 110 cm 37 - 43"	110 - 126 cm 43 - 50"	80 - 150 cm 32 - 59"
Weight	40 - 70 kg 88 - 154 lb	60 - 90 kg 132 - 198 lb	80 - >110 kg 176 - >242 lb	40 - >70 kg 88 - >154 lb

### THREE STEP FITTING

- 1 Loosen all the straps and buckles.
- 2 Put the PFD on and fasten any buckles. Do not tighten chest harness yet (if fitted).
- 3 Tighten all straps, starting from the waist and working upwards to the shoulder straps. Tighten and fasten chest harness. Finish by sitting down and checking shoulder straps.

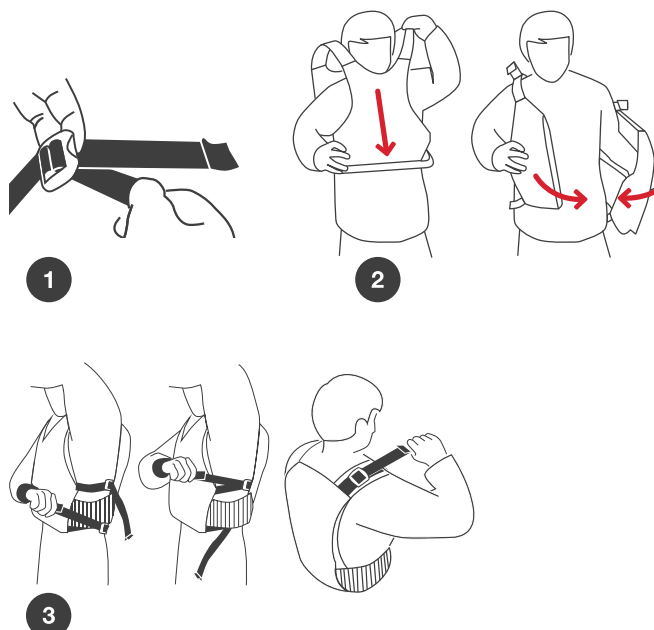

## OUTERWEAR + LAYERING SIZING

### MEN'S

	S	M	MB	MT	L	LT	XL	XXL
Euro	44 – 46	48	48 – 50	48 – 50	50	50 – 52	52 – 54	56
Height	170 – 174 cm 5'7 – 5'9"	174 – 178 cm 5'9 – 5'10"	174 – 178 cm 5'9 – 5'10"	178 – 182 cm 5'10 – 6'	178 – 182 cm 5'10 – 6'	182 – 186 cm 6' – 6'1"	182 – 186 cm 6' – 6'1"	186 – 190 cm 6'1 – 6'3"
Chest	86 – 94 cm 34 – 37"	94 – 102 cm 37 – 40"	102 – 110 cm 40 – 43"	94 – 102 cm 37 – 40"	102 – 110 cm 40 – 43"	102 – 110 cm 40 – 43"	110 – 118 cm 43 – 46"	118 – 126 cm 46 – 50"
Waist	72 – 80 cm 28 – 31"	80 – 88 cm 31 – 35"	88 – 96 cm 35 – 38"	80 – 88 cm 31 – 35"	88 – 96 cm 35 – 38"	88 – 96 cm 35 – 38"	96 – 104 cm 38 – 41"	104 – 112 cm 41 – 44"
Inside leg	76 – 78 cm 30 – 31"	78 – 80 cm 31 – 31"	78 – 80 cm 31 – 31"	80 – 82 cm 31 – 32"	80 – 82 cm 31 – 32"	82 – 84 cm 32 – 33"	82 – 84 cm 32 – 33"	84 – 86 cm 33 – 34"

### WOMEN'S

	WXS	WS	WSR	WM	WL	WXL
UK	8	10	10 – 12	12	14	16
Euro	36	38	38 – 40	40	42	44
US	6	8	8 – 10	10	12	14
Height	158 – 162 cm 5'2 – 5'4"	162 – 166 cm 5'4 – 5'5"	162 – 166 cm 5'4 – 5'5"	166 – 170 cm 5'5 – 5'7"	170 – 174 cm 5'7 – 5'9"	174 – 178 cm 5'9 – 5'10"
Bust	82 – 86 cm 32 – 34"	86 – 90 cm 34 – 35"	90 – 98 cm 35 – 39"	90 – 94 cm 35 – 37"	94 – 98 cm 37 – 39"	98 – 102 cm 39 – 40"
Waist	66 – 70 cm 26 – 28"	70 – 74 cm 28 – 29"	74 – 78 cm 29 – 31"	74 – 78 cm 29 – 31"	78 – 82 cm 31 – 32"	82 – 86 cm 32 – 34"
Hips	90 – 94 cm 35 – 37"	94 – 98 cm 37 – 39"	98 – 102 cm 39 – 40"	98 – 102 cm 39 – 40"	102 – 106 cm 40 – 42"	106 – 110 cm 42 – 43"
Inside leg	68 – 70 cm 27 – 28"	70 – 72 cm 28 – 28"	70 – 72 cm 28 – 28"	72 – 74 cm 28 – 29"	74 – 76 cm 29 – 30"	76 – 78 cm 30 – 31"

### IN-BETWEEN SIZES

**Outerwear** – MB (Medium Broad) for men has the length of a Medium and the width of a Large. WSR (Women's Small Relaxed) for women has the length of a Small and the width of a Medium.

**Layering & neoprene** – MT (Medium Tall) for men's longjohn wetsuits has the width of a Medium and the length of a Large.

## FOOTWEAR SIZING

Socks	S	S	M	M	L	L	XL	XL	XXL	XXL
UK	5	6	7	8	9	10	11	12	13	14
Euro	38	39	40 – 41	42	43	44 – 45	46	47	48	49
US	6	7	8	9	10	11	12	13	14	15
Length	24 cm	25 cm	26 cm	27 cm	27.5 cm	28.5 cm	29.5 cm	30.5 cm	31 cm	32 cm

## GLOVES SIZING

	S	M	L	XL	XXL
Length	17.5 – 18.5 cm	18.5 – 19.5 cm	19.5 – 20.5 cm	20.5 – 21 cm	>21 cm
	6.9 – 7.3"	7.3 – 7.7"	7.7 – 8"	8 – 8"	>8"
Circumference	19 – 20.5 cm	20.5 – 22 cm	22 – 23.5 cm	23.5 – 25 cm	>25 cm
	7.5 – 8.1"	8 – 8.7"	8.7"	9.3 – 9.8"	>9.8"

**Length**– measure from the tip of your longest finger to the base of your palm at the wrist.

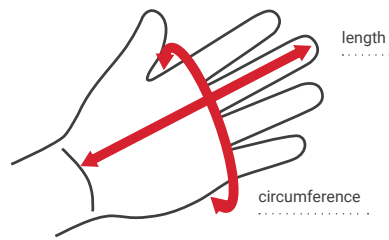

**Circumference**– wrap a tape measure around your hand at the widest part of the palm, and lightly close your hand before taking the measurement.

## HELMET SIZING

Size	AP2000	AP4000		SHUCK		
	ONE SIZE	S	L	S	M	L
Circumference	52 – 58 cm	51 – 56 cm	56 – 60 cm	51 – 54 cm	55 – 58 cm	59 – 62 cm
	20.5 – 22.8"	20 – 22"	22 – 23.6"	20 – 21.3"	21.7 – 22.8"	23.2 – 24.4"

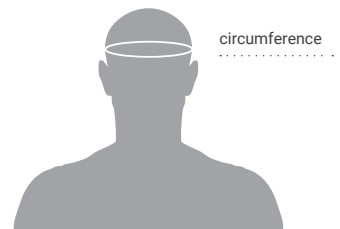

**Circumference**– measure around the largest area of the head, above the eyebrows and ears.

### FITTING A HELMET

- 1 Try on your helmet – it should cover your forehead with the peak just above your eyes – it should be a close fit, but not uncomfortably tight.
- 2 The helmet should not be able to move around on your head or be pulled back to expose your forehead.
- 3 Tighten or loosen the cradle at the back of your helmet to fit your head.
- 4 To change the helmet's front/back balance slide the straps through the three-way adjuster – take time to tension the chin straps equally.
- 5 Pull the chin strap through the quick release buckle to tighten under your chin – the fit should be snug, but not uncomfortably tight.
- 6 Try on your helmet – if the fit is still not satisfactory, repeat the steps. Add or remove fit pads (if supplied with your helmet).

2 helmet should cover forehead

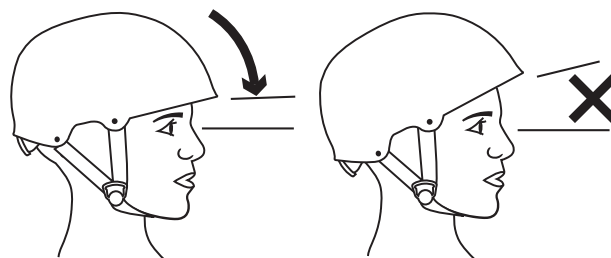

4 three-way strap adjuster

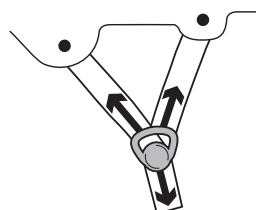

5 tighten chin strap

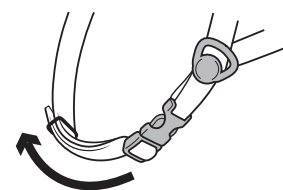

# Service

## MAINTENANCE + DOCUMENTATION

You'll find links to each product's certification booklet, instruction manual and the declaration of conformity on the corresponding product page of our website, where you can also find our maintenance guides and care advice for PFDs, helmets, throwlines and waterproof outerwear. We've also introduced serial numbering to our rescue PFDs to help with your inventory and inspection schedule.



## CUSTOMER SERVICE

We're committed to help service and maintain your equipment. Our customer service department can help with a range of factory repairs, from zip replacements to seam repair as well as water tank testing of suits and PFDs. For our range of standard services visit the help centre on our website. We have a range of spare parts available to order for those products which are user serviceable. You can contact our service team at [customer.services@palm.equipment](mailto:customer.services@palm.equipment)



## SPECIAL ORDER

If you require some of our branded products to be customised with your own logo, we can offer a selection of products and options for your organisation. Or if you have product you would like Palm to make for you, subject to minimum order quantities, please get in touch with us at [sales@palm.equipment](mailto:sales@palm.equipment)

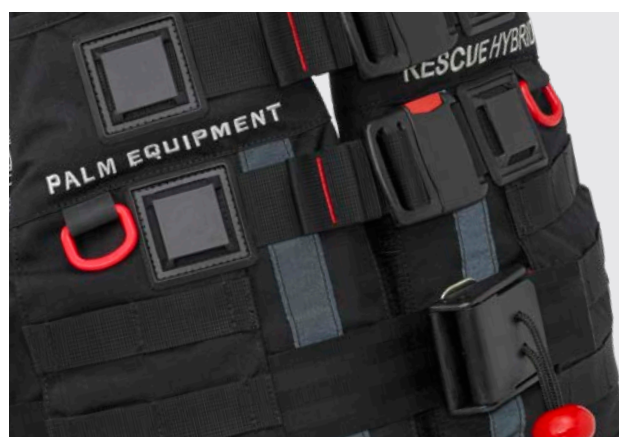



WWW.PALM.EQUIPMENT

---

## CONTACT

### Worldwide office

Palm Equipment International Ltd  
Kenn Business Park,  
Clevedon, Somerset,  
BS21 6TH, United Kingdom  
Telephone: +44 (0)1275 798100  
Fax: +44 (0)1275 798110  
info@palm.equipment

### Europe office

Palm Equipment GmbH  
Wilsberger Str. 7  
D-53567 Asbach, Germany  
Telephone: +49 (0)2683 93 92 60  
europe@palm.equipment

